



FENCER® SABER™ SELECT

PREMIUM DIFFUSION
LED FIXTURE

SPECIFICATION SHEET



OVERVIEW

FENCER® SABER™ SELECT PREMIUM DIFFUSION LED Fixtures incorporate a unique design with premium diffusion lens to create an uninterrupted linear light output, that totally eliminates the traditional “hot spots” of most LED array fixtures. It boasts a 98+ Color Rendering Index (CRI) that delivers exceptional color rendering, enhancing colors, patterns and natural details with a vibrant, flawless color representation.

FEATURES

- Selectable CCT- 3000K, 3500K, 4000K
- Premium diffused light. No LED hot spots
- 120VAC ETL Listed 1598 hard-wired luminaire
- Includes captive screws for easy installation
- Easy and fast retrofit for traditional fixtures
- Superior CRI and R values
- Daisy-chain multiple fixtures for long runs
- 5-year warranty

FINISHES



Satin
White

SELECTABLE LIGHT TEMPERATURE

3000K



3500K



4000K



SKU Builder

DI

- 120V -

SBRSEL

Model

- [] -

Length

WH

Color

8 16

24 32

Item #	
Project	

SPECIFICATIONS

- Input Voltage: 120VAC / 50 ~ 60 Hz
- Power Consumption: See chart below
- Max Daisy-Chain Run: 300W
- CRI: 90+
- Beam Angle: 120°
- Dimmable: Yes (See *Fencer SABER Dimmer Compatibility List*)
- Housing: Powder-coated Aluminum
- Ambient Temperature¹: -4° ~ 122°F (-20° ~ 50°C)
- Operating Temperature²: -4° ~ 176°F (-20° ~ 80°C)
- Environment: Indoor / dry location use only
- Included Items: 1x Romex Connector, 1x FENCER Linkable End-to-End Connector, 2x Mounting Screws, 2x Mounting Screw Covers
- Dimensions: See 'Mechanical Diagrams'

COMPLIANCE & REGULATORY APPROVALS

Safety

- ETL Listed Hard-Wired Luminaire (United States & Canada). Conforms to UL std. 1598, Luminaires. Certified to CSA std. C22.2 No. 9.0 (must be purchased with FENCER SABER Master On/Off Switch & Junction Box: DI-1305-** or FENCER SABER Occupancy Sensor: DI-120V-SABER-MS-**))

Performance

- LED chip data measured in accordance to IES LM-80-08.
- Photometric & Colorimetry data measured in accordance to IES LM-79-08, in Elemental LED's Innovation Lab.









FENCER® SABER™ SELECT FIXTURE MODELS

Item #	Fixture Length	Lumens ³ 3000K / 3500K / 4000K	Power Consumption	Efficacy ⁴ /Fixture (lm/W) 3000K / 3500K / 4000K
DI-120V-SBRSEL-8-WH	8.4 in.	374 / 418 / 403	6W	62 / 70 / 67
DI-120V-SBRSEL-16-WH	16.4 in.	610 / 683 / 676	9.6W	64 / 71 / 70
DI-120V-SBRSEL-24-WH	24.4 in.	890 / 981 / 981	14W	64 / 70 / 70
DI-120V-SBRSEL-32-WH	32.4 in.	1162 / 1263 / 1244	19.2W	61 / 66 / 65



FENCER® SABER™ SELECT ACCESSORIES

Item #	Finish	Product Description
DI-1305-WH	WH <input type="checkbox"/>	FENCER SABER/FOIL Master On/Off Switch & Junction Box
DI-1306-WH	WH <input type="checkbox"/>	FENCER SABER/FOIL Linkable End-to-End Connector
DI-1307-WH	WH <input type="checkbox"/>	FENCER SABER/FOIL 6 in. Extension Cable Cord Type: UL SVT 105C Cord
DI-1308-WH	WH <input type="checkbox"/>	FENCER SABER/FOIL 12 in. Extension Cable Cord Type: UL SVT 105C Cord
1309-WH	WH <input type="checkbox"/>	FENCER SABER/FOIL 24 in. Extension Cable Cord Type: UL SVT 105C Cord
1310-WH	WH <input type="checkbox"/>	FENCER SABER/FOIL 72 in. Extension Cable Cord Type: UL SVT 105C Cord
DI-1311-WH	WH <input type="checkbox"/>	FENCER SABER/FOIL 72 in. Power Cable with AC Plug Cord Type: UL SVT 105C Cord
DI-1312-WH	WH <input type="checkbox"/>	FENCER SABER/FOIL 72 in. Power Cable with Hard-Wire Connection Cord Type: UL SVT 105C Cord
DI-FENSEL-JBOX-WH	WH <input type="checkbox"/>	FENCER SABER/FOIL SELECT Junction Box

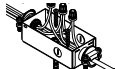
1. Do not install product in an environment outside the listed ambient temperature. Exceeding the maximum ambient temperature may damage LED chips, reduce the total lamp life, lumen output, and/or adversely impact color consistency.
2. Operating temperature is measured according to the minimum and maximum ambient temperature environment.
3. LED chips have a luminous flux range with a tolerance of +/- 5%.

FENCER® SABER™ MECHANICAL DIAGRAMS

8 IN. MODEL: DI-120-SBRSEL

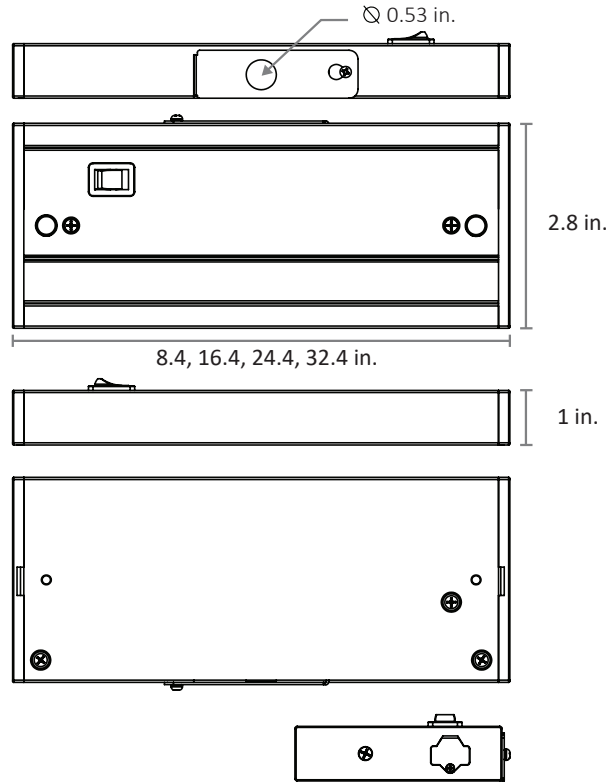

FENCER® SABER™ MOUNTING

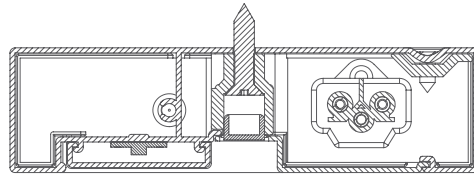

ADDITIONAL RESOURCES

FENCER® SERIES Dimmer Compatibility List

FENCER® SABER™ PREMIUM DIFFUSION Installation Guide

SAFETY / WARNINGS / DISCLOSURES

1. Install in accordance with the National Electric Code, and local regulations.
2. This product is intended to be installed and serviced by a qualified, licensed electrician.
3. Only install compatible LED fixtures & controls. Only use copper wiring.
4. Suitable for indoor dry locations only.
5. 300W maximum series daisy-chain connection.
6. Proper heat dissipation will prolong the working lifespan of this product. Install in a well-ventilated area free from explosive gases and vapors.
7. Ensure applicable wire is installed between driver, fixture, and any controls in between. When choosing wire, factor in voltage drop, amperage rating, and type (in-wall rated, wet location rated, etc.). Inadequate wire installation could overheat wires, and cause a fire.
8. Do not install if product has any visible damage.
9. Do not modify or disassemble this product beyond instructions or the warranty will be void.

WARRANTY

Limited Warranty

This product has a five (5) year limited warranty from the date of shipment. This warranty does not include the additional accessories referenced in this specification sheet. Complete warranty details for fixtures and additional accessories are available at www.diodeled.com/limited-warranty/ within the Policies section. For warranty related questions please contact product support.

Consumer's Acknowledgment

Diode LED stands behind its products when they are used properly and according to our specifications. By purchasing our products, the purchaser agrees and acknowledges that lighting design, configuration and installation is a complex process, wherein seemingly minor factors or changes in layout and in-field adjustments can have a significant impact on an entire system. Choosing the correct components is essential. Diode LED is able to work with the original purchaser to make an appropriate product selection to the extent of the limited information that the customer can provide, but it is virtually impossible for Diode LED to design a system that foresees every unknown factor. For this reason, this Warranty does not cover problems caused by improper design, configuration or installation issues. Any statement from a Diode LED employee or agent regarding a customer's bill of goods and/or purchase order is NOT an acknowledgment that the products purchased are designed and configured correctly. The purchase agrees and acknowledges that it is the customer's responsibility to adhere strictly to all information contained in the Product Specification Sheets.

There is often more than one way to design, configure and layout an LED lighting application properly to achieve the same lighting effect. Diode LED strongly recommends that licensed professionals be used in the design and installation of lighting systems that include Diode LED products. The specifications include important information that a designer and installer should carefully review and strictly follow. Qualified designers and certified and/or licensed installers, with access to the final installation environment, customer goals, and Diode LED product specifications can make the requisite decisions appropriate for a successful finished lighting application.



© 2019 Elemental LED, Inc. All rights reserved.
Specifications are subject to change without notice.

Toll Free: 877.817.6028 | Fax: 415.592.1596 | www.DiodeLED.com | info@DiodeLED.com